

# ARCHITECTURAL PRECAST



**EDS** CONCRETE  
PRODUCTS



# WE KNOW CONCRETE

With over 40 years of experience under our belt, we fabricate concrete products using the best of both traditional and today's leading edge technology. All of our products are designed and manufactured to meet or exceed requirements of CSA23.4 and ASTM C1364.

From first contact to product delivery, our motivated team of professionals is dedicated to providing you with an excellent product and attentive customer service, on schedule and within budget.

## CUSTOM PRECAST

ED'S Concrete maintains expansive design and fabrication facilities that support a wide range of custom precast projects. Let's discuss how we can make your design ideas a reality – from initial consultation through engineered design drawings, manufacturing and delivery, ED'S Concrete is professional and reliable.



### LANDSCAPE EXCELLENCE AWARDS

CPCI Wellness Bench  
Musee Picass

### ONTARIO CONCRETE AWARDS

Aitken Park, Toronto  
Lake Wilcox Promenade, Waterloo

### ONTARIO MASONRY DESIGN AWARDS

Richmond Woods II Apartments  
Holiday Inn Express  
St Mary's Hospital Annex  
Woodstock Hospital

▲ **Farringdon Church**  
*Architect: Phil Osburn & Associates*

▼ **Southwest Centre for Forensic Mental Health Care, St. Thomas**  
*Architects: Tillmann Ruth Robinson, London  
(jointly with Parkin Architects, Toronto)*







**North Oakville East Wastewater Pumping Station**  
*Architect: AECOM Canada Ltd.*  
*Contractor: DeFaveri Group Contracting Inc.*



**Private Residence, Conestogo**  
*Contractor: Van-Del Contracting Ltd.*

COLOURS & FINISHES	5
POSTCAPS	6
WALL COPING	10
SILLS & BANDING	12
SURROUNDS	16
ACCESSORIES	
KEYSTONES	17
CORBELS, CHICKLETS & QUOINS	18
ADDITIONAL CHIMNEY CAPS	18
SIGNS	19





**Elgin St. Thomas Public Health Unit**  
*Architect: Tillmann Ruth Robinson, London*



**Private Residence, Cambridge**  
*Contractor: Troika Custom Builders*



**The Bruce Hotel**  
*Architect: Marklevitz Architect*







# COLOURS

Products are manufactured in a STANDARD Grey colour unless one of our PREMIUM colours are specifically requested. We can also CUSTOM MATCH colours.

## STANDARD

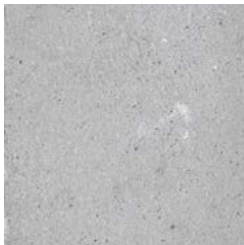

GREY

## PREMIUM



NUTMEG

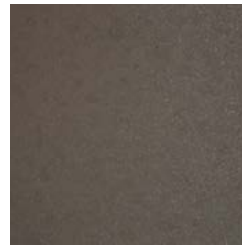

JAVA



EBONY

These swatches indicate general colour and finish only.

To ensure accuracy please request a sample from our office.

A natural variance in colour and finish is to be expected during the manufacturing process.



PARCHMENT



WHITE



BUFF

# FINISHES

Products are manufactured in a Smooth Precast finish unless the Acid Etched or Light Sandblasted finishes are specifically requested.

PREMIUM colours are recommended in Acid Etch or Sandblast finish.



## SMOOTH PRECAST

Our standard form finish is a smooth, touchable surface similar to a stone from the beach.



## ACID ETCH

Acid etching lightly penetrates the concrete surface, exposing the sands, deepening earth tones and creating a lightly textured finish.



## LIGHT SANDBLAST

Sandblasting exposes air pockets hidden below the surface of the concrete, resulting in a natural, organic texture.



# POST CAPS

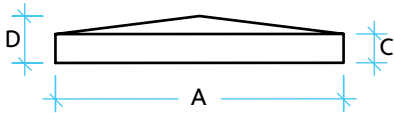
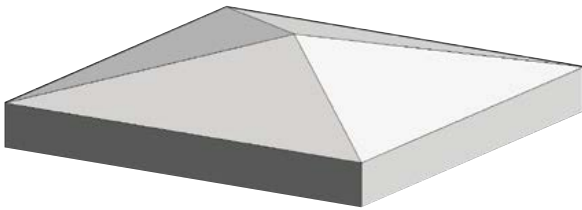

## PEAKED Post Cap | PCA

Available in 6 sizes:

	A	B	C	D
PCA16	16	16	2	3
PCA18	18	18	2	3 <sup>1</sup> / <sub>8</sub>
PCA20	20	20	2	3 <sup>1</sup> / <sub>4</sub>
PCA22	22	22	2	3 <sup>3</sup> / <sub>8</sub>
PCA24	24	24	2	3 <sup>1</sup> / <sub>2</sub>
PCA26	26	26	2	3 <sup>5</sup> / <sub>8</sub>

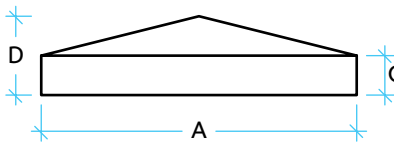

## PEAKED Post Cap | PCB

Available in 7 sizes:

	A	B	C	D
PCB16	16	16	3 <sup>1</sup> / <sub>2</sub>	5 <sup>1</sup> / <sub>2</sub>
PCB20	20	20	3 <sup>1</sup> / <sub>2</sub>	6
PCB24	24	24	3 <sup>1</sup> / <sub>2</sub>	6 <sup>1</sup> / <sub>2</sub>
PCB26	26	26	3 <sup>1</sup> / <sub>2</sub>	6 <sup>1</sup> / <sub>2</sub>
PCB28	28	28	3 <sup>1</sup> / <sub>2</sub>	7
PCB30	30	30	3 <sup>1</sup> / <sub>2</sub>	7 <sup>1</sup> / <sub>2</sub>
PCB32	32	32	3 <sup>1</sup> / <sub>2</sub>	7 <sup>1</sup> / <sub>2</sub>

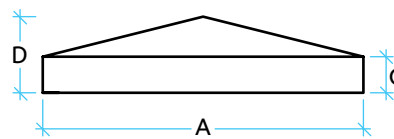

## PEAKED Post Cap | PCC

Available in 3 sizes:

	A	B	C	D
PCC36	36	36	4 <sup>1</sup> / <sub>2</sub>	9
PCC40	40	40	4 <sup>1</sup> / <sub>2</sub>	9 <sup>1</sup> / <sub>2</sub>
PCC44	44	44	4 <sup>1</sup> / <sub>2</sub>	10

Measurements are in inches.

All post caps 24" and larger come standard with a drip edge. If not required, please specify when ordering.

All post caps are available with holes in the centre. Peaked caps can be manufactured with flatspots for lights.

*Additional charges may apply.*

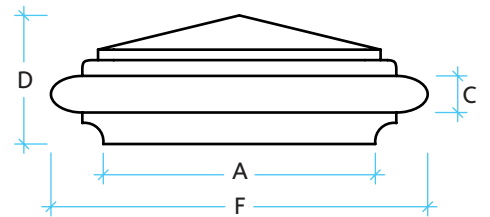
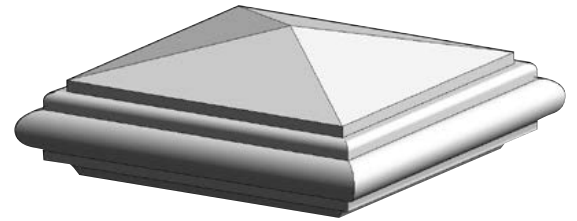

## FANCY Post Cap | PCG

Available in 4 sizes:

	A	B	C	D	F
PCG26	26	26	3 <sup>1</sup> / <sub>2</sub>	12 <sup>3</sup> / <sub>4</sub>	36
PCG32	32	32	3 <sup>1</sup> / <sub>2</sub>	13 <sup>1</sup> / <sub>2</sub>	42
PCG36	36	36	3 <sup>1</sup> / <sub>2</sub>	16	46
PCG40	40	40	3 <sup>1</sup> / <sub>2</sub>	14 <sup>1</sup> / <sub>2</sub>	50



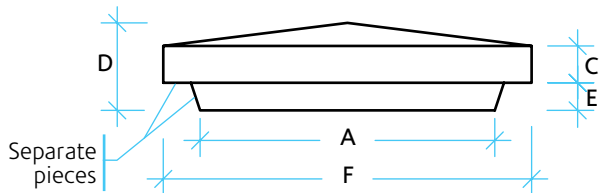
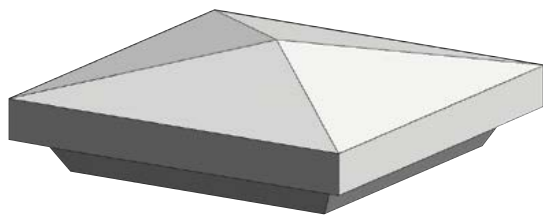

### PEAKED Post Cap with Base | PCD

Available in 4 sizes:

	A	B	C	D	E	F
<b>PCD20</b>	16	16	2	4 <sup>3</sup> / <sub>4</sub>	1 <sup>1</sup> / <sub>2</sub>	20
<b>PCD22</b>	18	18	2	4 <sup>7</sup> / <sub>8</sub>	1 <sup>1</sup> / <sub>2</sub>	22
<b>PCD24</b>	20	20	2	5	1 <sup>1</sup> / <sub>2</sub>	24
<b>PCD26</b>	22	22	2	5 <sup>1</sup> / <sub>8</sub>	1 <sup>1</sup> / <sub>2</sub>	26

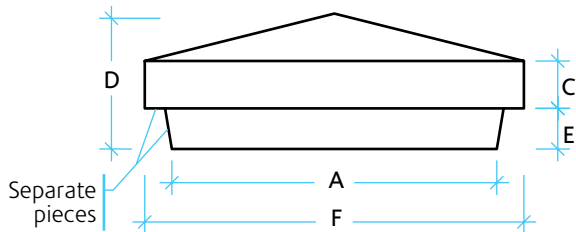

### PEAKED Post Cap with Base | PCE

Available in 3 sizes:

	A	B	C	D	E	F
<b>PCE20</b>	20	20	3 <sup>1</sup> / <sub>2</sub>	9 <sup>1</sup> / <sub>2</sub>	3	24
<b>PCE24</b>	24	24	3 <sup>1</sup> / <sub>2</sub>	10	3	28
<b>PCE28</b>	28	28	3 <sup>1</sup> / <sub>2</sub>	10 <sup>1</sup> / <sub>2</sub>	3	32

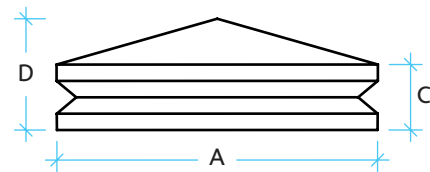
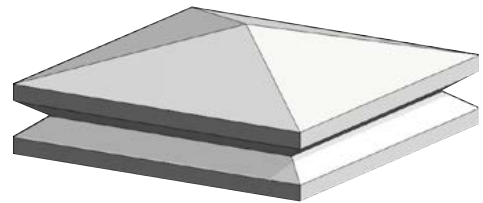

### 'V' NOTCHED Post Cap | PCH

Available in 3 sizes:

	A	B	C	D
<b>PCH20.5</b>	20 <sup>1</sup> / <sub>2</sub>	20 <sup>1</sup> / <sub>2</sub>	4 <sup>1</sup> / <sub>2</sub>	7 <sup>1</sup> / <sub>4</sub>
<b>PCH24.5</b>	24 <sup>1</sup> / <sub>2</sub>	24 <sup>1</sup> / <sub>2</sub>	5	8 <sup>1</sup> / <sub>2</sub>
<b>PCH29.5</b>	29 <sup>1</sup> / <sub>2</sub>	29 <sup>1</sup> / <sub>2</sub>	5 <sup>3</sup> / <sub>4</sub>	9 <sup>3</sup> / <sub>4</sub>

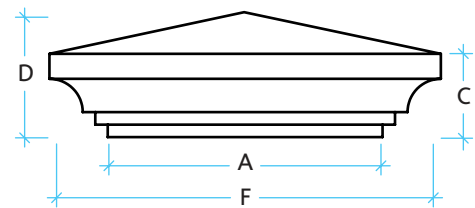

### ESTATE Post Cap | PCJ

Available in 2 sizes:

	A	B	C	D	F
<b>PCJ26</b>	26	26	7 <sup>3</sup> / <sub>4</sub>	11 <sup>3</sup> / <sub>4</sub>	37
<b>PCJ32</b>	32	32	9 <sup>3</sup> / <sub>4</sub>	14 <sup>1</sup> / <sub>2</sub>	45 <sup>1</sup> / <sub>2</sub>



# POST CAPS

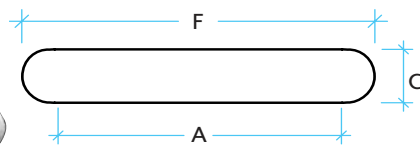
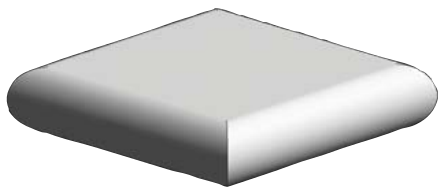

**BULLNOSE Post Cap | PCK**

Available in 2 sizes:

	A	B	C	F
<b>PCK22</b>	22	22	4	26
<b>PCK26</b>	26	26	4	30

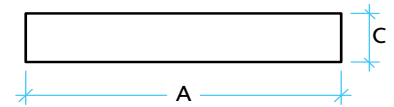
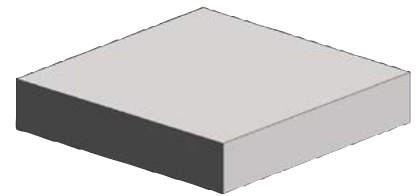

**SQUARE Post Cap | PCS**

Available in 6 sizes:

	A	B	C
<b>PCS16</b>	16	16	3 1/2
<b>PCS18</b>	18	18	3 1/2
<b>PCS20</b>	20	20	3 1/2
<b>PCS24</b>	24	24	3 1/2
<b>PCS28</b>	28	28	3 1/2
<b>PCS30</b>	30	30	3 1/2
<b>PCS32</b>	32	32	3 1/2

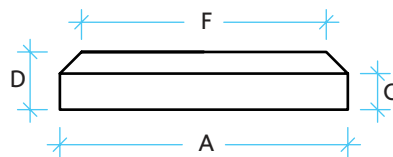
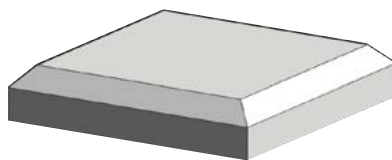

**CHAMFER Post Cap | PCF**

Available in 7 sizes:

	A	B	C	D	F
<b>PCF16</b>	16	16	2 1/2	4	13
<b>PCF18</b>	18	18	2 1/2	4	15
<b>PCF20</b>	20	20	2 1/2	4	17
<b>PCF22</b>	22	22	2 1/2	4	19
<b>PCF24</b>	24	24	2 1/2	4	21
<b>PCF28</b>	28	28	2 1/2	4	25
<b>PCF30</b>	30	30	2 1/2	4	27

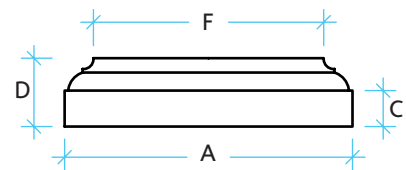
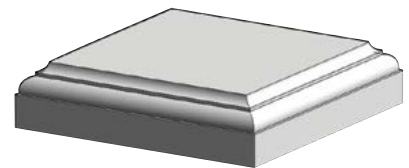

**TIERED Post Cap | PCT**

Available in 6 sizes:

	A	B	C	D	F
<b>PCT14</b>	14	14	2 1/2	4 3/4	10
<b>PCT16</b>	16	16	2 1/2	4 3/4	12
<b>PCT18</b>	18	18	2 1/2	4 3/4	14
<b>PCT20</b>	20	20	2 1/2	4 3/4	16
<b>PCT22</b>	22	22	2 1/2	4 3/4	18
<b>PCT24</b>	24	24	2 1/2	4 3/4	20



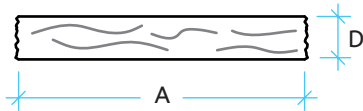
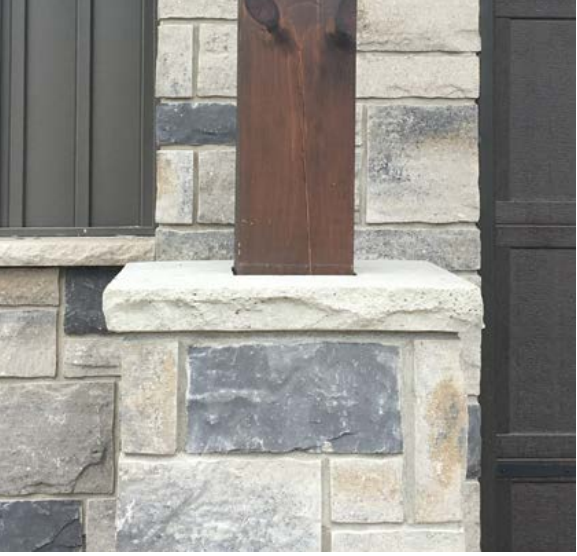

### ROCK-FACED Post Cap | PCR

Available in 10 sizes and custom:

	A	B	D
PCR16	16	16	3
PCR17	17	17	3
PCR18	18	18	3
PCR20	20	20	3
PCR22	22	22	3
PCR24	24	24	3
PCR26	26	26	3
PCR28	28	28	3
PCR30	30	30	3
PCR32	32	32	3

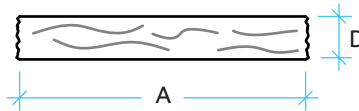

### CUSTOM ROCK-FACED Post Cap | PCRC

Available in any combination of A & B up to maximum indicated. Please note variation in thickness.

	A	B	D
PCRC-2	48	48	2
PCRC-3	96	96	3
PCRC-4	60	72	4
PCRC-5	60	48	5
PCRC-6	48	48	6

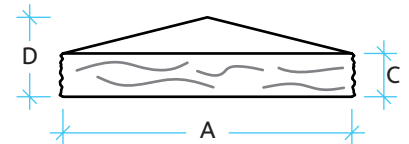
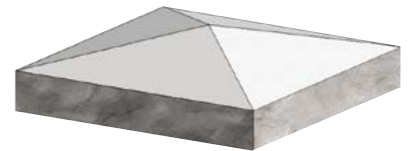

### ROCK-FACED PEAKED Post Cap | PCI

Available in 2 sizes:

	A	B	C	D
PCI24	24	24	3 1/2	6 1/2
PCI26	26	26	3 1/2	6 3/4

Measurements are in inches. All post caps 24" and larger come standard with a drip edge. If not required, please specify when ordering.

All post caps are available with holes in the centre. Peaked caps can be manufactured with flatspots for lights. Additional charges may apply.

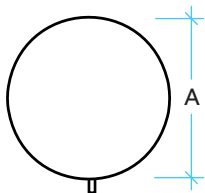
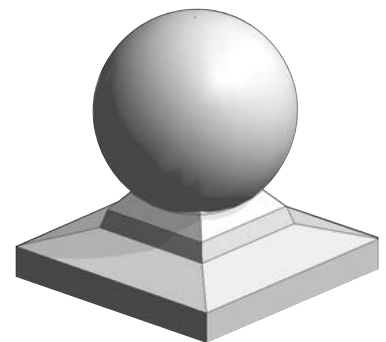

### BALL Only | BL

Available in 6 sizes:

	A
BL8	8
BL10	10
BL12	12
BL16	16
BL24	24
BL30	30

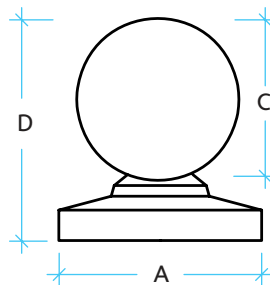

### BALL Post Cap with BASE | BLB

Available in 3 sizes:

	A	B	C	D
BLB8	10	10	8	13
BLB10	12	12	10	15
BLB12	15 3/4	15 3/4	12	17



# WALL COPING

All measurements in inches.  
 Wall coping comes standard with a drip cut.  
 Custom lengths available up to maximum length noted in size charts under column "L".

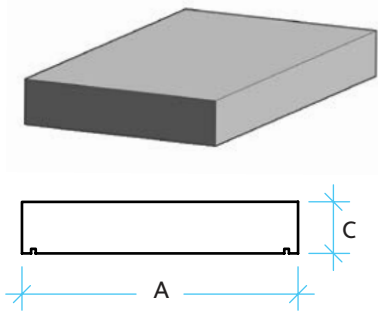

## SQUARE Wall Coping | WCS

Available in 7 widths:

	A	C	L
<b>WCS10</b>	10	3 1/2	96
<b>WCS12</b>	12	3 1/2	72
<b>WCS14</b>	14	3 1/2	60
<b>WCS16</b>	16	3 1/2	60
<b>WCS18</b>	18	3 1/2	60
<b>WCS20</b>	20	3 1/2	60
<b>WCS24</b>	24	3 1/2	72

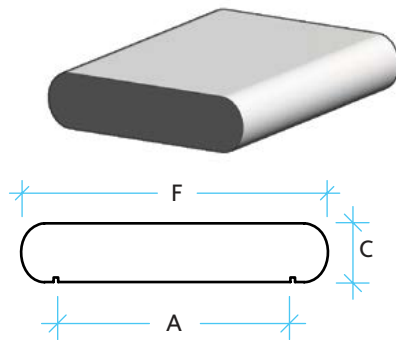

## BULLNOSE Wall Coping | WCK

Available in 2 widths:

	A	C	F	L
<b>WCK8</b>	8	4	12	60
<b>WCK18</b>	18	4	22	72

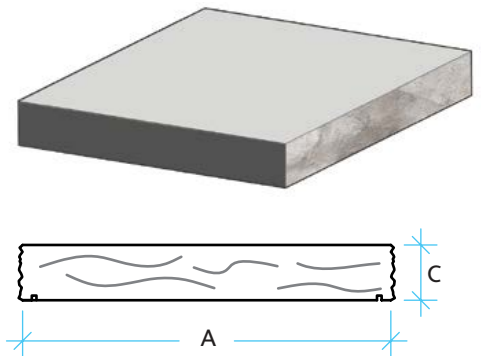

## ROCK-FACED FLAT Wall Coping | WCR

Available in 5 widths and custom:

	A	C*	L
<b>WCR10</b>	10	3	48
<b>WCR12</b>	12	3	72
<b>WCR16</b>	16	3	48
<b>WCR17</b>	17	3	48
<b>WCR20</b>	20	3	48

## CUSTOM ROCK-FACED

See **PCRC**, page 9



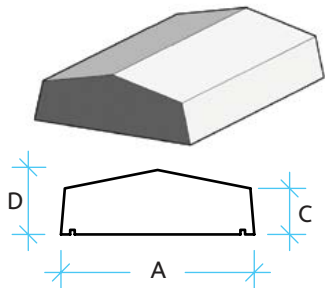

### PEAKED Wall Coping | WCA

Available in 9 widths:

	A	C	D	L
WCA10.5	10 $\frac{1}{2}$	2 $\frac{1}{2}$	3 $\frac{1}{4}$	60
WCA12	12	3	4	60
WCA14	14	3	4	72
WCA15	15	3	4	72
WCA16	16	3	4	72
WCA18	18	3	4	60
WCA20	20	3	4	60
WCA22	22	2 $\frac{1}{2}$	3 $\frac{1}{2}$	60
WCA29	29	2 $\frac{1}{2}$	3 $\frac{1}{2}$	60

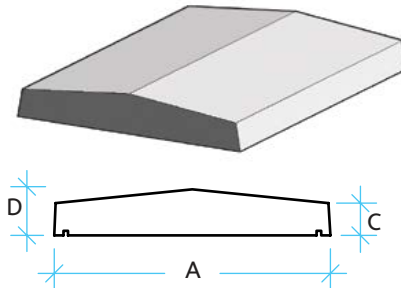

### PEAKED Wall Coping | WCC

Available in 6 widths:

	A	C	D	L
WCC12	12	2	2 $\frac{1}{2}$	84
WCC15	15	2	2 $\frac{1}{2}$	72
WCC17.5	17 $\frac{1}{2}$	2	2 $\frac{1}{2}$	72
WCC20	20	2	2 $\frac{1}{2}$	72
WCC24	24	2	2 $\frac{1}{2}$	72
WCC26	26	2	2 $\frac{1}{2}$	60

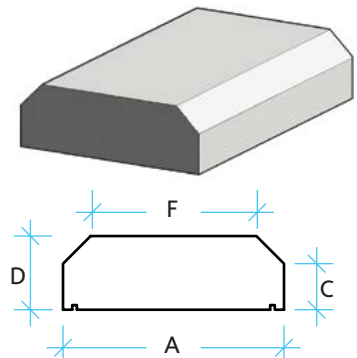

### CHAMFER Wall Coping | WCB

Available in 8 widths:

	A	C	D	F	L
WCB10.5	10 $\frac{1}{2}$	2 $\frac{1}{2}$	4	7 $\frac{1}{2}$	60
WCB12	12	2 $\frac{1}{2}$	4	9	60
WCB15	15	2 $\frac{1}{2}$	4	12	60
WCB16	16	2 $\frac{1}{2}$	4	13	60
WCB18	18	2 $\frac{1}{2}$	4	21	72
WCB20	20	2 $\frac{1}{2}$	4	17	60
WCB22	22	2 $\frac{1}{2}$	4	21	72
WCB24	24	2 $\frac{1}{2}$	4	21	72

### POOL Coping | WSPCAS

Non-slip bumps  
One size only  
Maximum length 24"

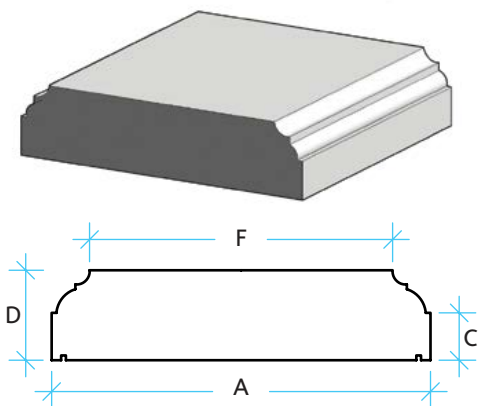
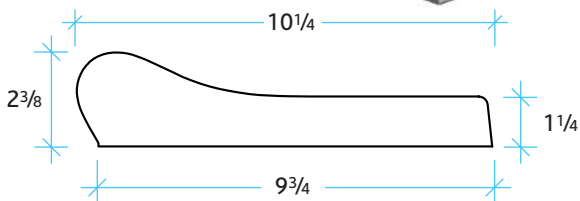
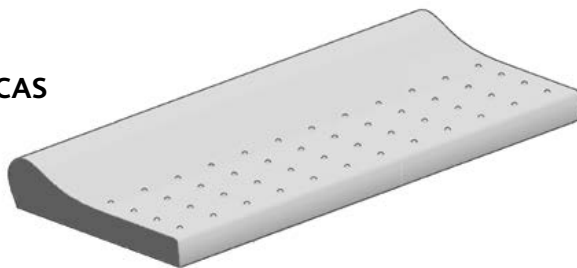

### TIERED Wall Coping | WCT

Available in 2 widths:

	A	C	D	F	L
WCT12	12	2 $\frac{1}{2}$	4 $\frac{3}{4}$	8	72
WCT16	16	2 $\frac{1}{2}$	4 $\frac{3}{4}$	12	60



## 2" HEIGHT

### SL01 |

LENGTH  
Standard 60"  
Maximum 72"

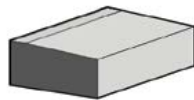
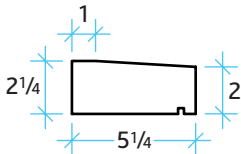

### SL46 |

LENGTH  
Standard 58 3/4"  
Maximum 72"

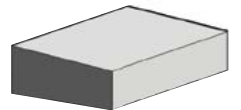
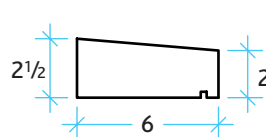

### SL02 |

LENGTH  
Standard 60"  
Maximum 72"

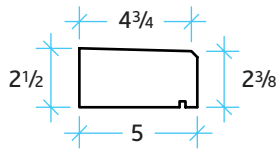

### SB01\* |

LENGTH  
Standard 48"  
Maximum 78"  
\*Corner Unit Available

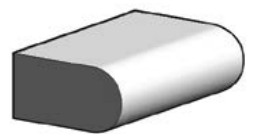
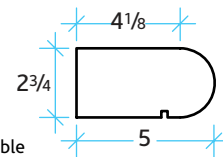

## 3" HEIGHT

### SLRF3\*\* |

LENGTH  
Standard 60"  
Maximum 96"

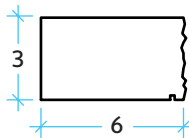

\*\*ROCK-FACE available in 3", 4", 5" and 6" heights

### SL11 |

LENGTH  
Standard 72"  
Maximum 72"

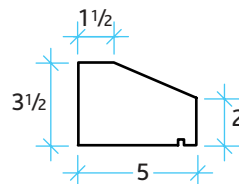

### SL67\* |

LENGTH  
Standard 68"  
Maximum 96"  
\*Corner Unit Available

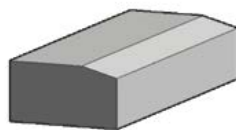
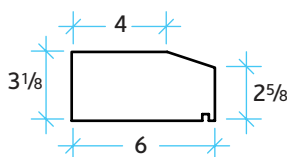

### SL12\* |

LENGTH  
Standard 72"  
Maximum 120"  
\*Corner Unit Available

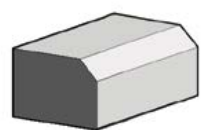
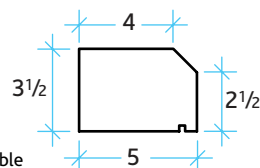

### SL07\* |

LENGTH  
Standard 72"  
Maximum 120"  
\*Corner Unit Available

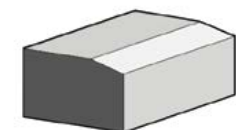
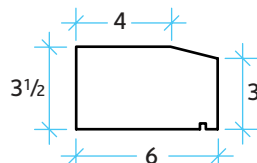

### SL48 |

LENGTH  
Standard 72"  
Maximum 72"

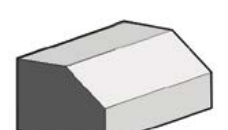
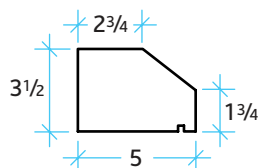

### SL08\* |

LENGTH  
Standard 60"  
Maximum 120"  
\*Corner Unit Available

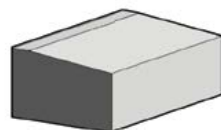
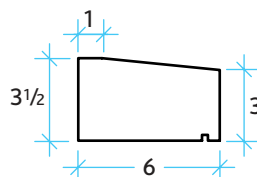

### SB02\* |

LENGTH  
Standard 60"  
Maximum 78"  
\*Corner Unit Available

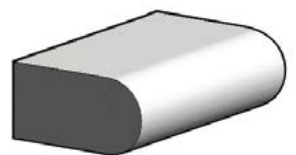
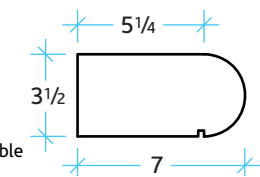





# SILLS & BANDING

All measurement in inches.  
Sills and banding come standard with a drip cut. Custom lengths are available up to maximum length.

## 4" HEIGHT

<p><b>SL15  </b> LENGTH Standard 72" Maximum 144"</p>			<p><b>SL20  </b> LENGTH Standard 72" Maximum 96"</p>		
<p><b>SL16  </b> LENGTH Standard 48" Maximum 96"</p>			<p><b>SL22  </b> LENGTH Standard 60" Maximum 60"</p>		
<p><b>SL17  </b> LENGTH Standard 72" Maximum 96"</p>			<p><b>SL54*  </b> LENGTH Standard 60" Maximum 60" *Corner Unit Available</p>		
<p><b>SL18  </b> LENGTH Standard 72" Maximum 96"</p>			<p><b>SL60  </b> LENGTH Standard 72" Maximum 96"</p>		
<p><b>SL19*  </b> LENGTH Standard 60" Maximum 96" *Corner Unit Available</p>			<p><b>SL53  </b> LENGTH Standard 60" Maximum 60"</p>		

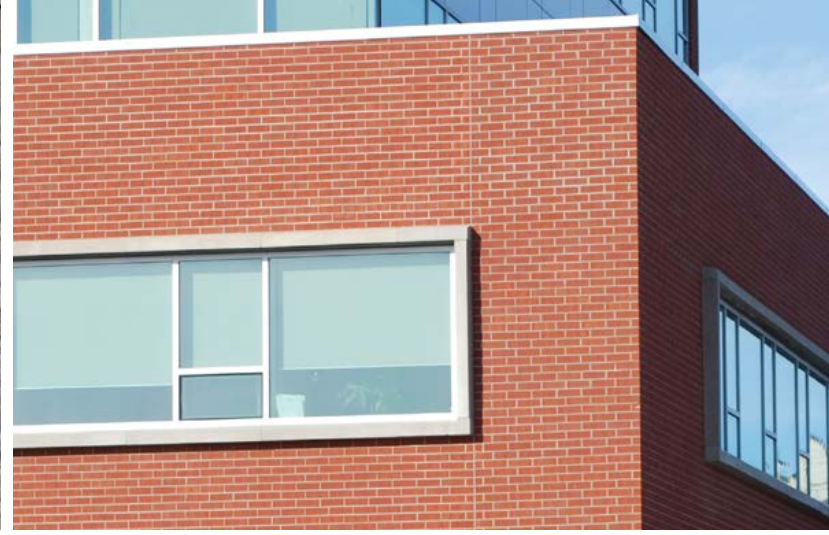

# SILLS & BANDING

All measurement in inches.  
Sills and banding come standard with a drip cut. Custom lengths are available up to maximum length.

## 5" HEIGHT

**SL23 |**  
LENGTH  
Standard 60"  
Maximum 140"

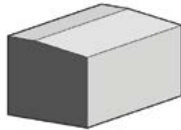
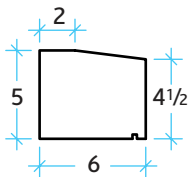

**SL27 |**  
LENGTH  
Standard 60"  
Maximum 60"

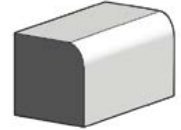
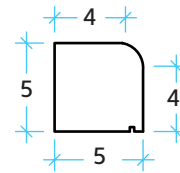

**SL24\* |**  
LENGTH  
Standard 60"  
Maximum 84"  
\*Corner Unit Available

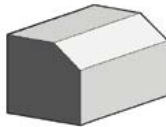
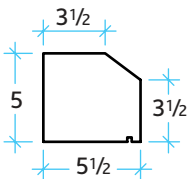

**SL51 |**  
LENGTH  
Standard 67"  
Maximum 86"

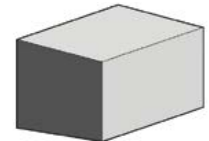
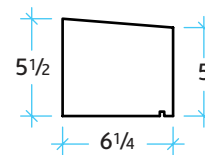

## 6" HEIGHT

**SL69 |**  
LENGTH  
Standard 72"  
Maximum 96"

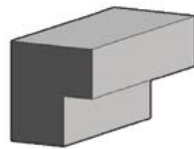
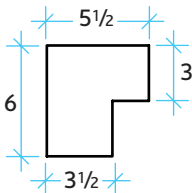

**SL31 |**  
LENGTH  
Standard 60"  
Maximum 60"

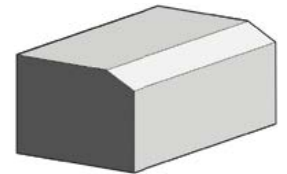
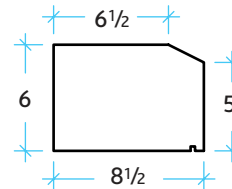

**SL29 |**  
LENGTH  
Standard 60"  
Maximum 99"

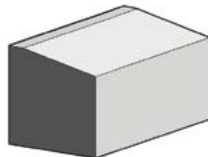
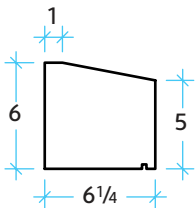

**SB03 |**  
LENGTH  
Standard 48"  
Maximum 48"

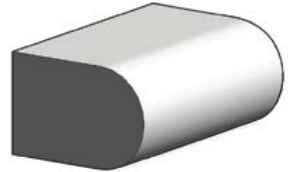
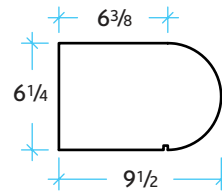

**SL30 |**  
LENGTH  
Standard 60"  
Maximum 60"

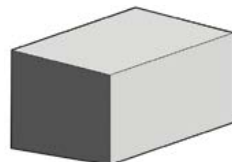
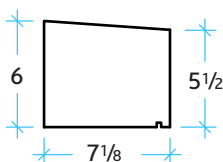

**SL32 |**  
LENGTH  
Standard 56"  
Maximum 72"

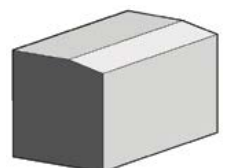
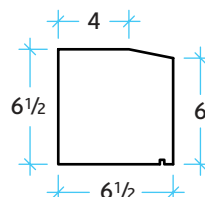





## 7" HEIGHT

**SL34 |**  
LENGTH  
Standard 60"  
Maximum 60"

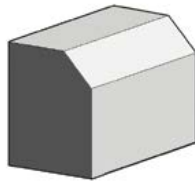
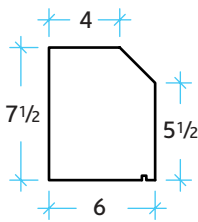

**SL44 |**  
LENGTH  
Standard 60"  
Maximum 60"

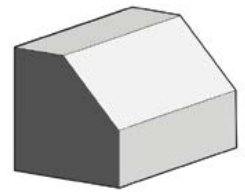
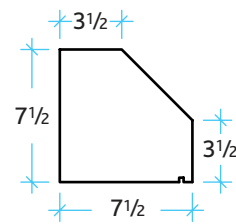

**SL36 |**  
LENGTH  
Standard 60"  
Maximum 60"

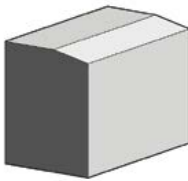
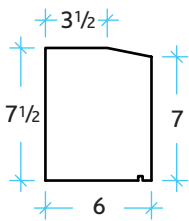

**SL52 |**  
LENGTH  
Standard 72"  
Maximum 72"

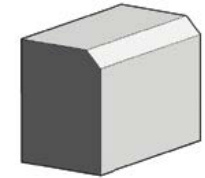
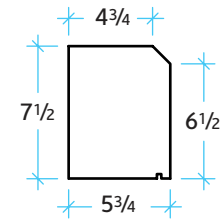

**SL70 |**  
LENGTH  
Standard 48"  
Maximum 48"

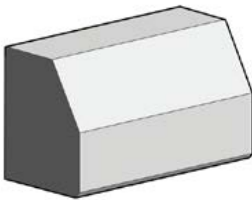
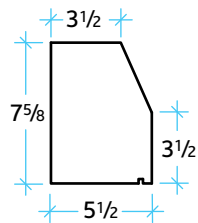

**SL33 |**  
LENGTH  
Standard 48"  
Maximum 48"

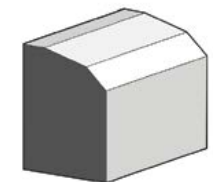
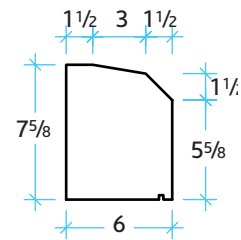

**SL71 |**  
LENGTH  
Standard 48"  
Maximum 48"

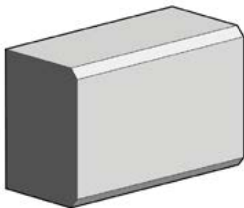
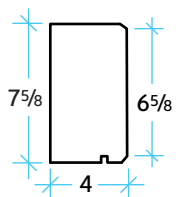

## 8" HEIGHT

**SL38 |**  
LENGTH  
Standard 60"  
Maximum 60"

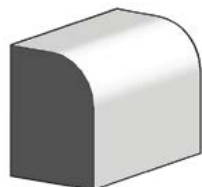
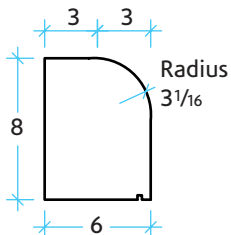

**SL39 |**  
LENGTH  
Standard 60"  
Maximum 60"

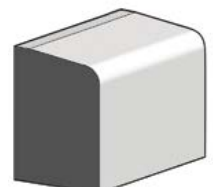
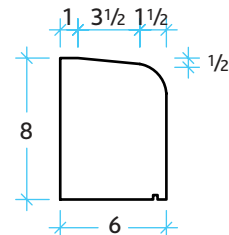



# SURROUNDS

PROFILED SURROUNDS are available at the noted lengths. Longer lengths can be achieved with a motor joint or combining a keystone.

Lintels have the option to be load bearing, eliminating the need for steel lintels in most cases, All lintels can be made to accept various style of keystones. Typical is flat ends, but can have return ends, flared ends, or profiled to match.

Custom shapes, such as arches can be made to match profiles. *Mold charges may apply.* All measurements in inches.

## PSS01 |

LENGTH  
Standard 60"  
Maximum 96"

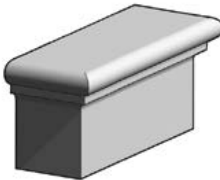
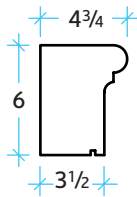

## PSS09 |

LENGTH  
Standard 72"  
Maximum 96"

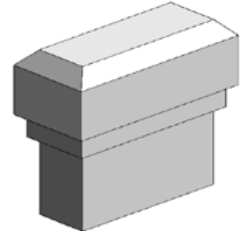
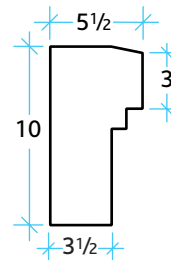

## PSS02 |

LENGTH  
Standard 60"  
Maximum 96"

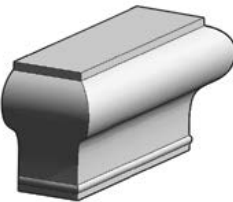
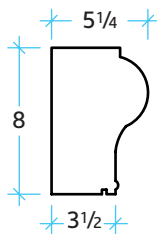

## PSS10 |

LENGTH  
Standard 96"  
Maximum 96"

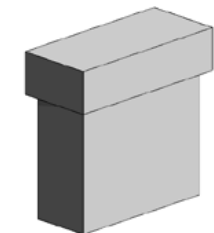
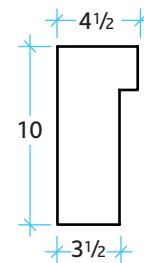

## PSS06 |

LENGTH  
Standard 60"  
Maximum 96"

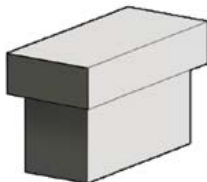
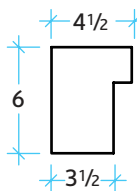

## PSS12 |

LENGTH  
Standard 48"  
Maximum 96"

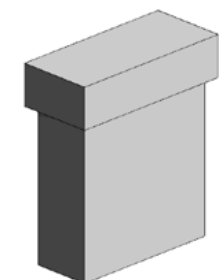
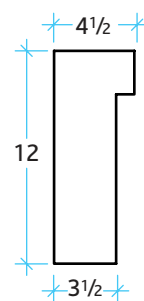

## PSS08 |

LENGTH  
Standard 72"  
Maximum 96"

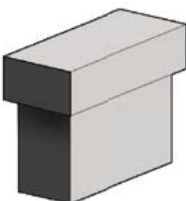
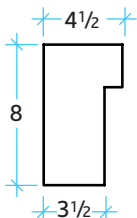



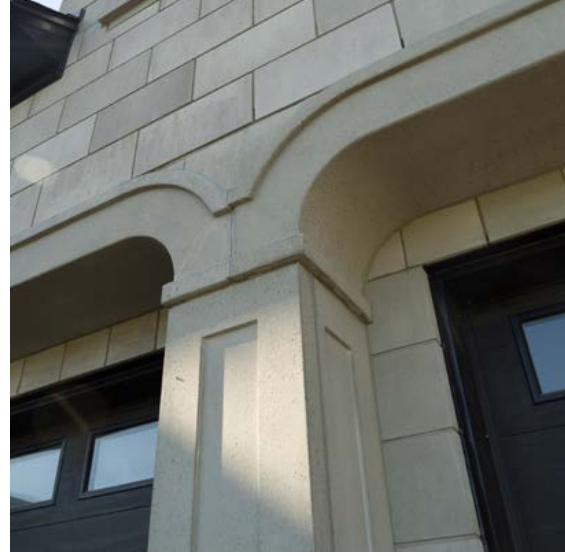

**SU00** | LENGTH

Standard 72" Maximum 96"

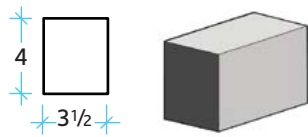

**SU01** | LENGTH

Standard 72" Maximum 96"

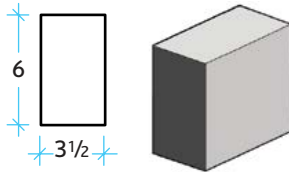

**SU05** | LENGTH

Standard 72" Maximum 108"

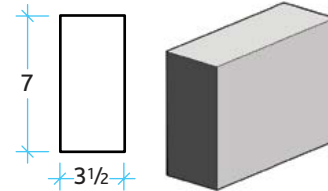

**SU02** | LENGTH

Standard 72" Maximum 96"

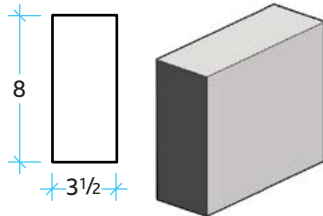

**SU03** | LENGTH

Standard 72" Maximum 96"

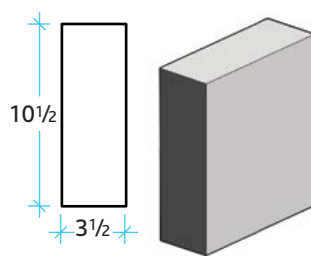

**SU04** | LENGTH

Standard 72" Maximum 96"

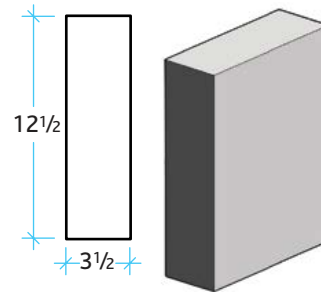

## KEYSTONES

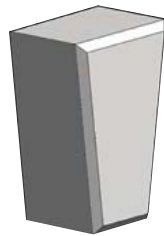
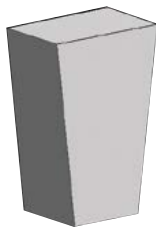
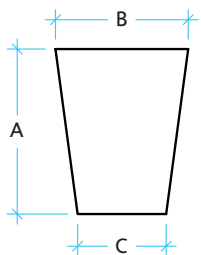

**Smooth | KSS**

Available in 4 sizes:

	A	B	C
<b>KSS8</b>	8	5	4
<b>KSS10</b>	10 1/4	8 1/2	5 1/2
<b>KSS12</b>	12 1/4	8 3/4	5 1/2
<b>KSS14</b>	14 1/4	9 1/4	5 1/2

**Bevelled | KSB**

Available in 3 sizes:

	A	B	C
<b>KSB10</b>	10 1/4	8 1/2	5 1/2
<b>KSB12</b>	12 1/4	8 3/4	5 1/2
<b>KSB14</b>	14 1/4	9 1/4	5 1/2

**Rock-faced | KSR**

Available in 3 sizes:

	A	B	C
<b>KSR5</b>	5 1/4	5 1/4	3
<b>KSR10</b>	10 1/4	8 1/2	5 1/2
<b>KSR12</b>	12 1/4	8 3/4	5 1/2

**Rock-faced with wings | KSWR**

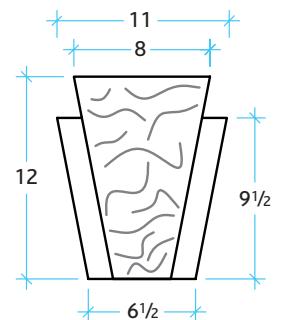



## CORBELS, CHICKLETS & QUOINS

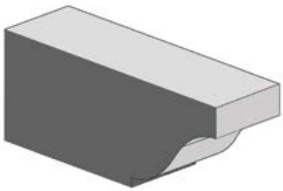

**CORBEL | WSCB**

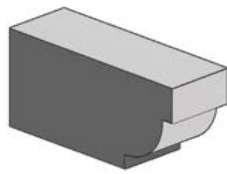
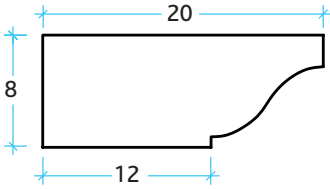

**CHICKLET | WSCH**

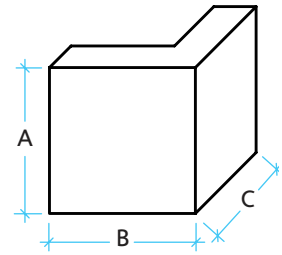
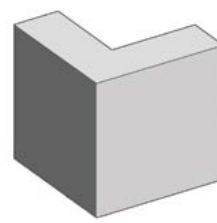
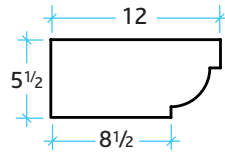

**QUOIN | WSQU**

Available in 2 sizes:

	A	B	C
<b>WSQU</b>	10 <sup>1</sup> / <sub>8</sub>	10 <sup>1</sup> / <sub>8</sub>	10 <sup>1</sup> / <sub>8</sub>
<b>WSQU-14</b>	14 <sup>1</sup> / <sub>8</sub>	14 <sup>1</sup> / <sub>8</sub>	14 <sup>1</sup> / <sub>8</sub>

## CHIMNEY CAPS

Available in 15 sizes. U caps and stretchers combine for a custom fit. All chimney caps have a drip edge. Measurements in inches.

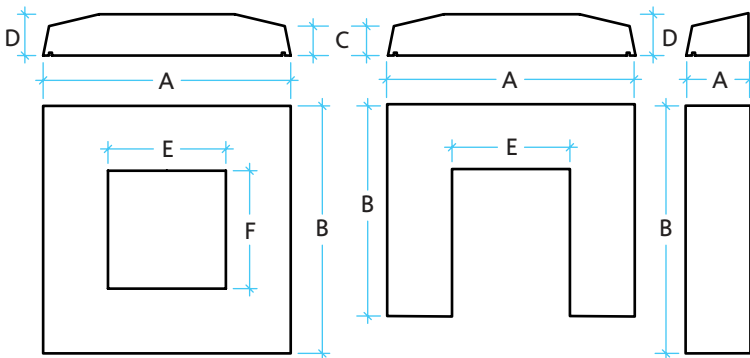
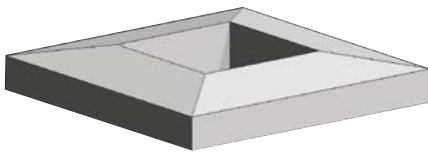

	A	B	C	D	E	F
<b>WSCC2-2</b>	21	21	2 <sup>1</sup> / <sub>2</sub>	3 <sup>1</sup> / <sub>2</sub>	10	10
<b>WSCC2-2.5</b>	21	25	2 <sup>1</sup> / <sub>2</sub>	3 <sup>1</sup> / <sub>2</sub>	10	14
<b>WSCC2-3</b>	21	29 <sup>1</sup> / <sub>2</sub>	2 <sup>1</sup> / <sub>2</sub>	3 <sup>1</sup> / <sub>2</sub>	10	18 <sup>1</sup> / <sub>2</sub>
<b>WSCC2-3.5</b>	21	34 <sup>1</sup> / <sub>2</sub>	2 <sup>1</sup> / <sub>2</sub>	3 <sup>1</sup> / <sub>2</sub>	10	24
<b>WSCC2-4</b>	21	39	2 <sup>1</sup> / <sub>2</sub>	3 <sup>1</sup> / <sub>2</sub>	10	28
<b>WSCC2-4.5</b>	21	42 <sup>1</sup> / <sub>2</sub>	2 <sup>1</sup> / <sub>2</sub>	3 <sup>1</sup> / <sub>2</sub>	10	31 <sup>1</sup> / <sub>2</sub>
<b>WSCC2-5</b>	21	47	2 <sup>1</sup> / <sub>2</sub>	3 <sup>1</sup> / <sub>2</sub>	10	36
<b>WSCC2-5.5</b>	21	51 <sup>1</sup> / <sub>2</sub>	2 <sup>1</sup> / <sub>2</sub>	3 <sup>1</sup> / <sub>2</sub>	10	40 <sup>1</sup> / <sub>2</sub>
<b>WSCC2-6</b>	21	57	2 <sup>1</sup> / <sub>2</sub>	3 <sup>1</sup> / <sub>2</sub>	10	46
<b>WSCC2.5-2.5</b>	25	25	2 <sup>1</sup> / <sub>2</sub>	3 <sup>1</sup> / <sub>2</sub>	14	14
<b>WSCC2.5-3</b>	25	29 <sup>1</sup> / <sub>2</sub>	2 <sup>1</sup> / <sub>2</sub>	3 <sup>1</sup> / <sub>2</sub>	14	18 <sup>1</sup> / <sub>2</sub>
<b>WSCC2.5-3.5</b>	25	34 <sup>1</sup> / <sub>2</sub>	2 <sup>1</sup> / <sub>2</sub>	3 <sup>1</sup> / <sub>2</sub>	14	24
<b>WSCC2.5-4</b>	25	39	2 <sup>1</sup> / <sub>2</sub>	3 <sup>1</sup> / <sub>2</sub>	14	28
<b>WSCC2.5-4.5</b>	25	42 <sup>1</sup> / <sub>2</sub>	2 <sup>1</sup> / <sub>2</sub>	3 <sup>1</sup> / <sub>2</sub>	14	31 <sup>1</sup> / <sub>2</sub>
<b>WSCC3-3</b>	29	29	2 <sup>1</sup> / <sub>2</sub>	3 <sup>1</sup> / <sub>2</sub>	14	18 <sup>1</sup> / <sub>2</sub>

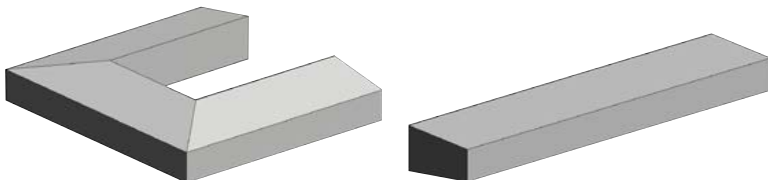

	A	B	C	D	E	F
<b>WSUC U Caps</b>	21	19	2 <sup>1</sup> / <sub>2</sub>	3 <sup>1</sup> / <sub>2</sub>	10	10
<b>WSSTR Stretchers</b>	5 <sup>1</sup> / <sub>2</sub>	21	2 <sup>1</sup> / <sub>2</sub>	3 <sup>1</sup> / <sub>2</sub>	-	-



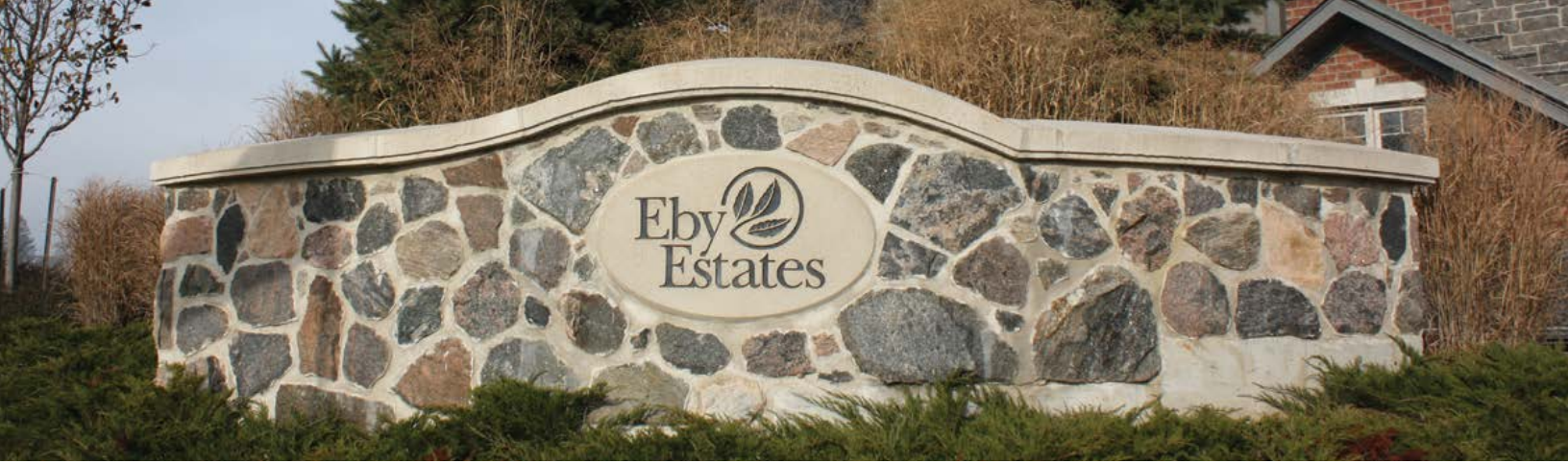

# SIGNS

If you want a sign to last a lifetime concrete is the way to go. Combine the best equipment in the industry with on-site craftsmen and the possibilities are limitless. Bring us your vision and we will make it come to life.



Visit [edsconcrete.com](http://edsconcrete.com) to explore all our precast concrete products.

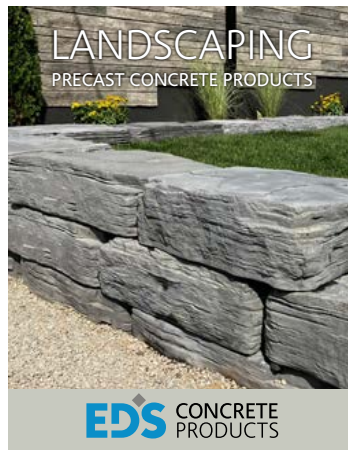
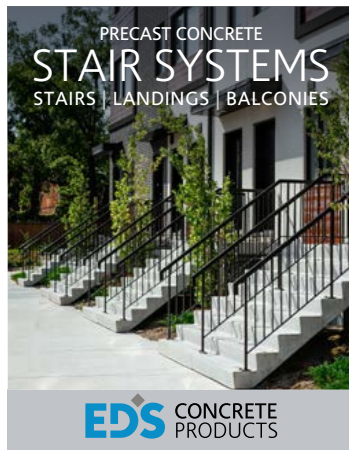





**Goderich Town Hall**  
*Architect: Allan Avis Architects Inc.*



**Private Residence, Thorndale**  
*Contractor: Shawn Elliott Homes*



**STRATFORD** | Head Office  
1266 Erie Street, Stratford  
ON Canada N4Z 0A1  
T 519-271-6590

**NORWICH**  
773098 Oxford Road 59  
Norwich ON Canada N0J 1P1  
T 519-468-6979

**TOLL FREE 1-877-265-6590**  
[edsconcrete.com](http://edsconcrete.com)  
f x @ p in